

>

USER'S MANUAL

Version 1.1



EASY AIRPRESS Standard 4 FP

Pneumatic Airpress

CONTENTS

1	Safety	3
1.1	Safety notes	3
1.2	Nameplate and "CE" marking	3
1.3	Warning signs	4
2	Technical Description	5
2.1	General information	5
2.2	The eyelet punching process	5
2.3	Components	6
2.4	Technical data	6
3	Installation	7
3.1	Scope of delivery	7
3.2	Installation of the handle	8
3.3	Installation of the die for metal eyelet	8
3.4	Installation of the die for plastic eyelets	10
3.5	Compressed air connection	13
3.6	Optional accessories	13
3.7	Installation of the optional trolley	14
3.8	Installation of the optional LED pointer	15
3.9	Replacing the batteries of the LED pointer	17
3.10	Installation of the optional spacer	18
4	Changing the Dies	19
4.1	Metal eyelets > metal eyelets	19
4.2	Plastic eyelets > plastic eyelets	20
4.3	Metal eyelets > plastic eyelets	21
4.4	Plastic eyelets > metal eyelets	23
5	Adjustments	25
5.1	Die for metal eyelets	25
5.2	Die for plastic eyelets	26
5.3	Finger guard	28
6	CE Declaration of Conformity	28

Thank you for deciding to purchase the EMBLEM Easy Airpress Standard 4. Before using your new machine please carefully read the safety notes and the explanations for installation, operation and changing dies in this manual.

1 Safety

1.1 Safety notes

Always disconnect the device from the compressed air supply before performing the following work on the machine:

- Changing the dies
- Cleaning, adjustment or maintenance
- Repairs

The outlet pressure of the compressor must be regulated so that a maximum pressure of 7 bars (101 psi) in the device is never exceeded. A pressure higher than 7 bars can damage the device and cause serious injuries to the operator. The device operates with a pressure of 5-7 bars. It is designed to give the best results for an air pressure of 6 bars. Permanent operation with a pressure above 6 bars increases wear.

1.2 Nameplate and "CE" marking



1.3 Warning signs



Caution!
Risk of injury

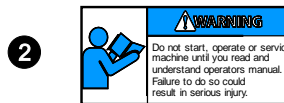

Warning!
Do not operate or repair the device unless you have read and understood the User's Manual.
Failure to do so jeopardises your health.



Caution!
Only qualified technicians may adjust the finger guard.

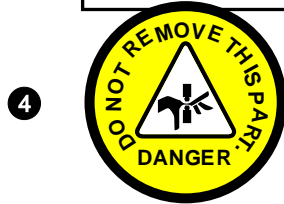

Danger!
Do not remove this part.

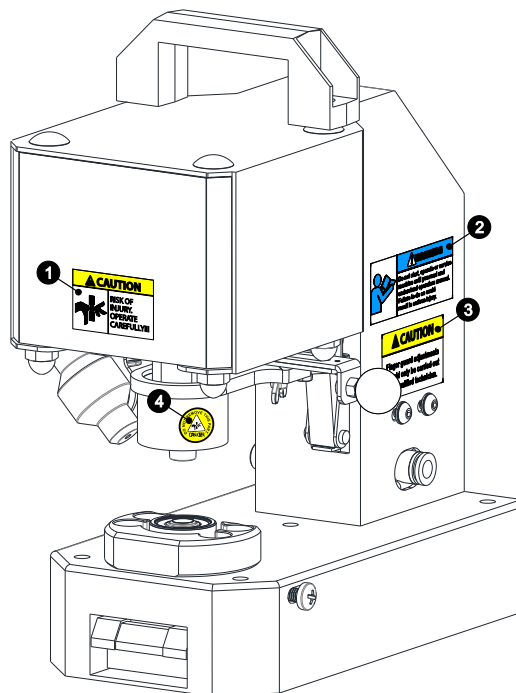

2 Technical Description

2.1 General information

The Easy Airpress Standard 4 is a portable pneumatic air press with which one can safely and efficiently attach eyelets to different materials, such as banners, marquees, tarpaulins, flags, signs or posters.

The pneumatic pressing of the eyelets is executed in a single step, i.e. punching the banner and setting in the eyelet.

By replacing the die, the device can press different metal eyelets from 8mm to 18.2mm in addition to transparent 12mm plastic eyelets.

With both the plastic dies and the metal dies, the cut out parts of the banner are pressed through the upper die into a practical collecting container which can be easily emptied from time to time.

2.2 The eyelet punching process

The operator presses the grommet into the upper die, where it is automatically held. The washer is placed into the lower die. The banner is then positioned between the two dies and the punching process started with the footpedal. Alternatively, the operator can start the process by actuating the manual operating lever.

The compressed air drives the piston downwards and the eyelet is pressed in a single step.

After releasing the pedal or the manual operating lever the piston returns to the upper position and the finished banner with eyelet can be removed.

2.3 Components

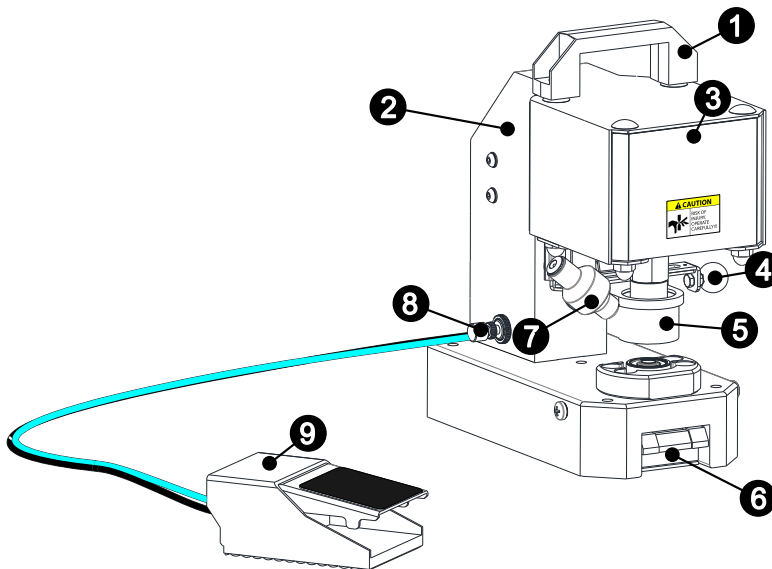

1. Handle
2. Housing
3. Cylinder
4. Manual operating lever
5. Finger guard
6. Punch waste collecting container
7. LED pointer (optional)
8. Speed control for finger guard
9. Footpedal

2.4 Technical data

Device description	EMBLEM Easy Airpress Standard 4FP
Safety system	Sensor-controlled finger guard
Compressed air supply	8mm directly connected
Operating pressure	5-7 bars (72-101 psi)
Air consumption	3.15L (0.83 gallons) per punching process, at 6 bars (85psi) operating pressure
Recommended compressor	8 bars, tank capacity min. 10L at 85L/min suction capacity
Noise level	76dB (A)
Pressing force	4.7kN / 480kgF / 1058 lbf at 6 bars (85 psi) operating pressure
Weight	7.2 kg
Dimensions	120mm x 245mm x 285mm

3 Installation

3.1 Scope of delivery

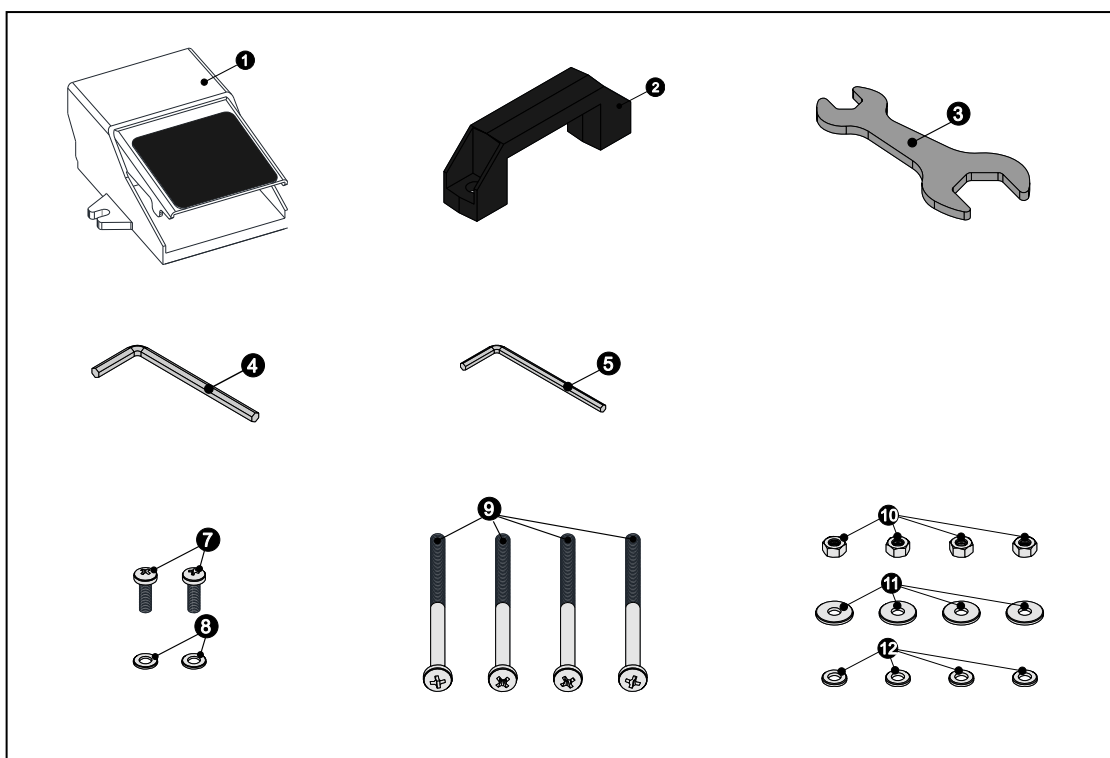

- 1 Footpedal
- 2 Handle
- 3 Open-end spanner
- 4 Allen wrench 4mm
- 5 Allen wrench 3mm
- 7 M5x16 screw
- 8 A5.3 washer
- 9 M6x60 screw
- 10 M6 nut
- 11 A6.4 washer (18mm)
- 12 A6.4 washer
- 13 Airpress (not pictured)
- 14 This manual

3.2 Installation of the handle



Screw the handle onto the upper side of the device.

3.3 Installation of the die for metal eyelets

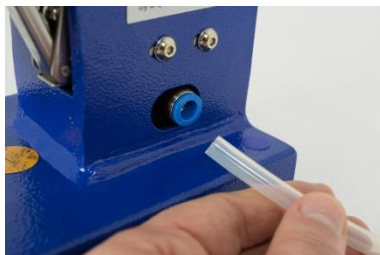

1. Remove the compressed air hose.

For the remainder of the installation procedure there must be no pressure on the device!



2. Make certain that the adapter nut is firmly tightened, using the open-end spanner supplied.



3. Turn the upper die as far as possible into the adapter nut.



4. Actuate the manual operating lever to drive the finger guard downwards.

Turn the upper die all the way into the adapter nut and tighten with the fingers.



5. Loosen the right screw for the lower die with a screwdriver.

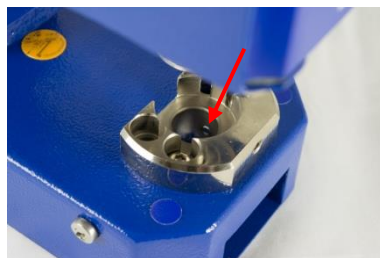

6. Turn out the screw until it is no longer visible in the hole.



7. Insert the lower die into the hole and press up to the stop.



8. Tighten the screw for the lower die and then check the adjustment as described in Section 5.1. Faulty adjustment causes poor results and can damage the die.

3.4 Installation of the die for plastic eyelets



1. Remove the compressed air hose.

For the remainder of the installation procedure there must be no pressure on the device!

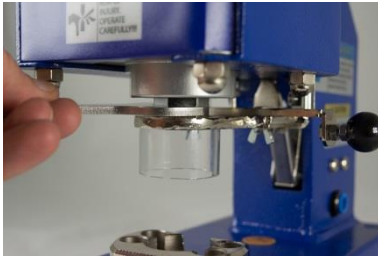

2. Remove the adapter nut using the open-end spanner.

The adapter nut is not required for this die. Save the adapter nut for later use with a die for metal eyelets.

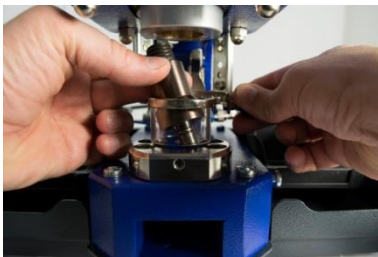

3. Actuate the manual operating lever to drive the finger guard downwards.

Slide the upper die over the finger guard and turn the die into the upper mount.



4. Tighten the upper die using the open-end spanner supplied.



5. Loosen the right screw for the lower die with a screwdriver.

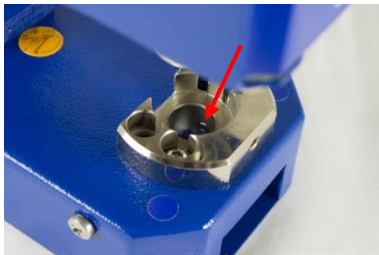

6. Turn out the screw until it is no longer visible in the hole.



7. Insert the lower die into the hole and press up to the stop.

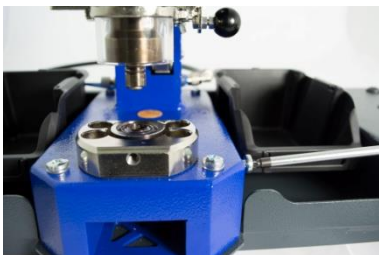

8. Tighten the screw for the lower die.



9. Loosen the two front screws on the lower bracket.



10. Pull the upper die downwards with the fingers and move the lower bracket so that the upper die fits into the hole of the lower die without snagging.



11. Tighten the two front screws on the lower bracket.



12. Slide the upper die several times completely into the lower die and control that the upper die is centred in the lower die without snagging.

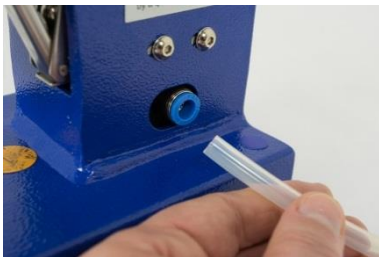

13. Connect the compressed air hose.



14. Drive the finger guard with the manual operation lever slowly downwards and control that the upper die is centred in the lower die without snagging. If this is not the case, adjust the die as described in Section 5.1.

Faulty adjustment causes poor results and can damage the die. Such damage is not under warranty!

3.5 Compressed air connection



The device has a quick coupling connection on the right side. Attach the open 8mm compressed air hose to the coupling, which automatically holds the hose. To remove the hose, press the snap ring on the connection and simultaneously pull out the hose.

The outlet pressure of the compressor must be regulated so that a maximum pressure of 7 bars (101 psi) in the device is never exceeded. A pressure higher than 7 bars can damage the device and cause serious injuries to the operator.

The device operates with a pressure of 5-7 bars. It is designed to give the best results for an air pressure of 6 bars. Permanent operation with a pressure above 6 bars increases wear.

3.6 Optional accessories

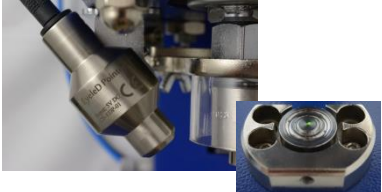
The following optional accessories are available:

Art. no.	Description	Illustration
25044	<p style="text-align: center;">Trolley</p> <p>including two holders for the grommets and washers and angular adapter for compressed air connection</p>	
25045	<p style="text-align: center;">LED pointer I</p> <p>including power supply and battery compartment</p>	
20918	<p style="text-align: center;">Spacer</p>	
25102	Eyelet mount for 8mm metal eyelets	Not pictured
25103	Eyelet mount for 9.5mm metal eyelets	
25042	Eyelet mount for 11mm metal eyelets	
25104	Eyelet mount for 18.2mm metal eyelets	
25043	Eyelet mount for 12mm plastic eyelets	



3.7 Installation of the optional trolley



1. Remove the four blue stickers over the drill holes.



2. Remove the four plastic feet on the lower side.



3. Screw the device onto the trolley.

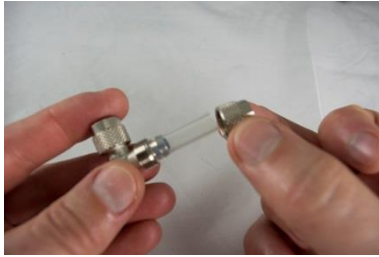

4. Cut away a piece (approx. 25mm long) of the compressed air hose (not supplied) and attach it to the angular piece supplied.



5. Attach the other end of the 25mm long hose to the connection on the device.

3.8 Installation of the optional LED pointer



1. Prepare the LED pointer as shown in the photo at the left. You may have to screw this onto the bracket.



2. Remove the nut from the rear left screw.



3. Attach the Laser pointer on the screw, but don't yet tighten the nut.

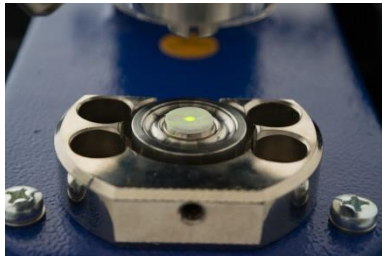

4. Lay a punched banner section in the centre of the die. For multi-layer punching lay several accordingly over each other. Then adjust the laser point so that it points to the centre of the punched section.



5. To adjust towards the front and rear rotate the bracket in the horizontal plane.

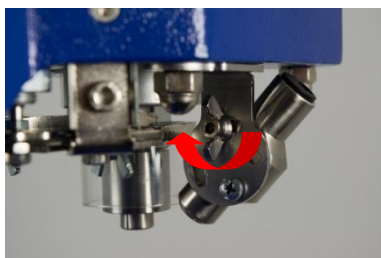

6. To adjust towards the left and right rotate the pointer. The Phillips-head screw is the fulcrum and under the wing screw is an elongated hole for adjusting the position.



7. Actuate the manual operating lever downwards to check that the upper die cannot collide with the LED pointer.



8. Connect the power supply to the pointer or glue the battery compartment to a suitable spot und connect.

3.9 Replacing the batteries of the LED pointer

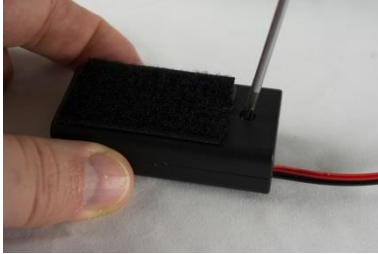

1. To replace the batteries in the battery compartment remove the locking screw.

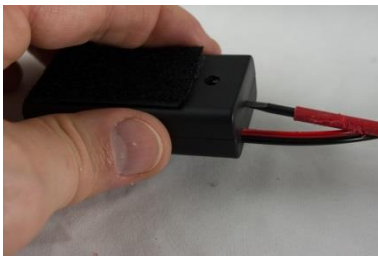

2. Then insert a flat screwdriver into the mount and carefully rotate.



3. The cover should then lift on this side.

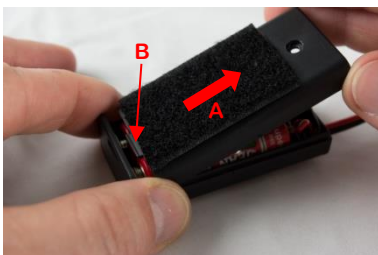

4. Pull the cover in the direction of the arrow A and carefully turn it upwards. Take care that the nib B does not break off.

5. Replace the two batteries with the battery type AA-Mignon. Ensure the correct polarity.

Then proceed in the opposite sequence to close the battery compartment again.

3.10 Installation of the optional spacer



1. Remove the yellow sticker and the upper and lower dies.

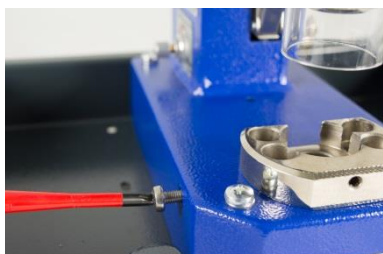

2. Remove the left screw.

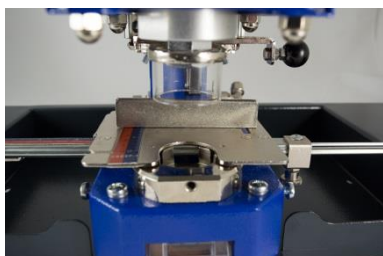

3. Position the spacer so that pins A, B and C fit into the corresponding holes A, B and C. Press the spacer all the way down.

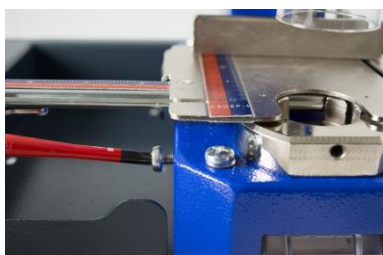
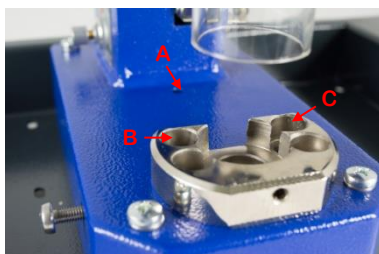
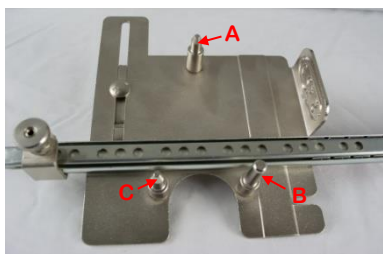

4. Fix the spacer with the left screw.

4 Changing the dies

4.1 Metal eyelets > metal eyelets

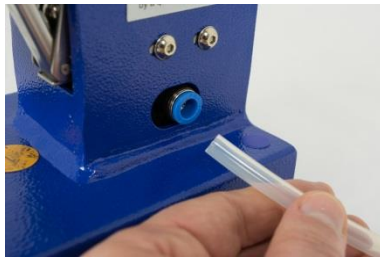

1. Remove the compressed air hose.

For the remainder of the installation procedure there must be no pressure on the device!



2. Actuate the manual operating lever to drive the finger guard downwards.

Loosen the upper die with the open-end spanner and turn out as far as possible.



3. Actuate the manual operating lever to drive the finger guard upwards and turn out the die completely.



4. Loosen the right screw for the lower die with a screwdriver.

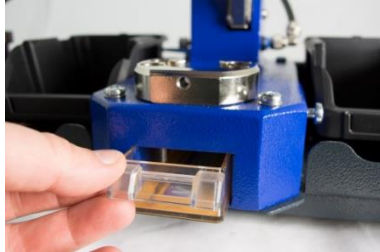

5. Remove the punch waste collecting container. Press the lower die upwards with the finger and remove the die.

Continue as described from Step 2 in Section 3.3.

4.2 Plastic eyelets > plastic eyelets

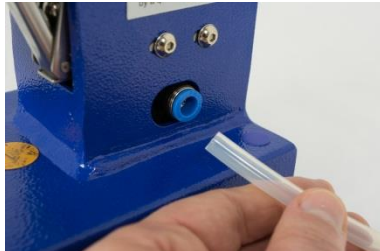

1. Remove the compressed air hose.

For the remainder of the installation procedure there must be no pressure on the device!



2. Actuate the manual operating lever to drive the finger guard downwards.

Loosen the upper die with the open-end spanner supplied and turn it out completely.



3. Loosen the right screw for the lower die with a screwdriver.

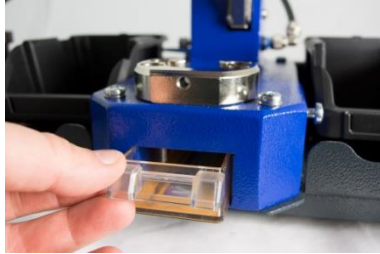

4. Remove the punch waste collecting container. Press the lower die upwards with the finger and remove the die.

Continue as described from Step 3 in Section 3.4.

4.3 Metal eyelets > plastic eyelets

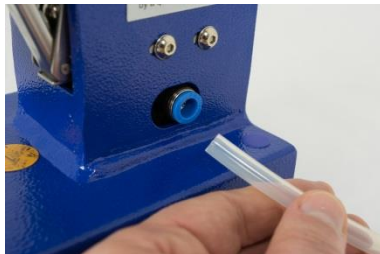

1. Remove the compressed air hose.

For the remainder of the installation procedure there must be no pressure on the device!



2. Actuate the manual operating lever to drive the finger guard downwards.

Loosen the upper die with the open-end spanner supplied and turn out as far as possible.



3. Drive the finger guard upwards and turn out the upper die completely.

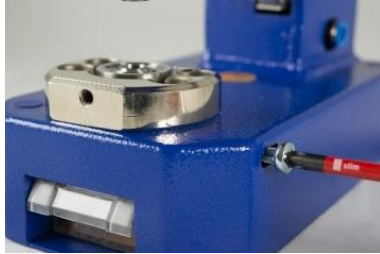

4. Loosen the right screw for the lower die with a screwdriver.

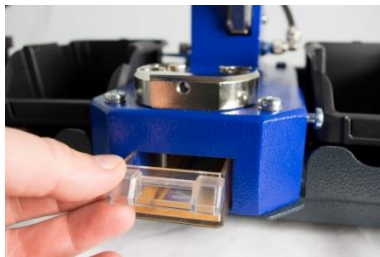

5. Remove the punch waste collecting container. Press the lower die upwards with the finger and remove the die.

Continue as described from Step 2 in Section 3.4.

4.4 Plastic eyelets > metal eyelets



1. Remove the compressed air hose.

For the remainder of the installation procedure there must be no pressure on the device!



2. Actuate the manual operating lever to drive the finger guard downwards.

Loosen the upper die with the open-end spanner supplied and turn it out completely.

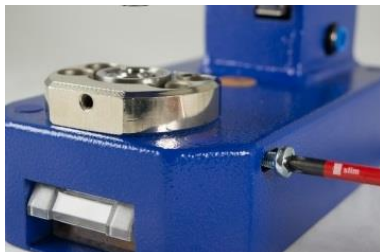

3. Loosen the right screw for the lower die with a screwdriver.

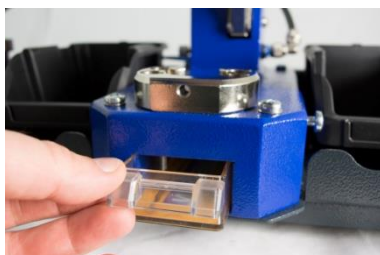

4. Remove the punch waste collecting container. Press the lower die upwards with the finger and remove the die.



5. Actuate the manual operating lever to drive the finger guard downwards.

Slide the adapter nut for the upper die over the finger guard and turn it into the upper mount.

Tighten the adapter nut with the open-end spanner supplied.

Continue as described from Step 3 in Section 3.3.

5 Adjustments

The precise adjustment of the dies is the prerequisite for excellent punching results. The punching results can change as a result of transport, changes in ambient conditions or wear. It is therefore necessary to control the adjustment from time to time, particularly after changing the dies or following unsatisfactory punching results. Faulty adjustment can damage the dies.

5.1 Die for metal eyelets

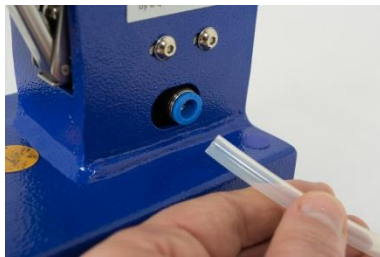

1. Remove the compressed air hose.

For the remainder of the installation procedure there must be no pressure on the device!

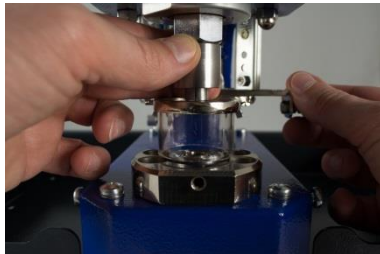

2. Actuate the manual operating lever to drive the finger guard downwards.
Then pull the upper die downwards with the other hand.

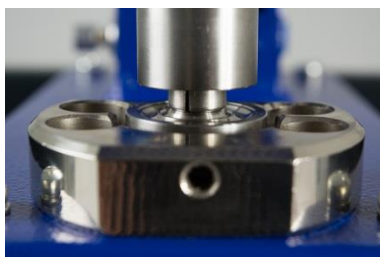

3. Check the position of the upper die relative to the lower die. The dies must be exactly centred over each other.

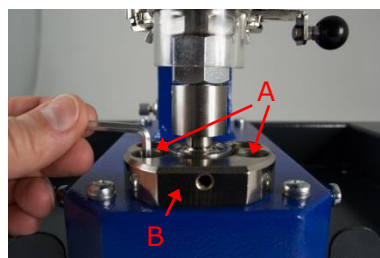

4. If necessary, loosen the two Allen screws A and slide the lower bracket B together with the die to the correct position.

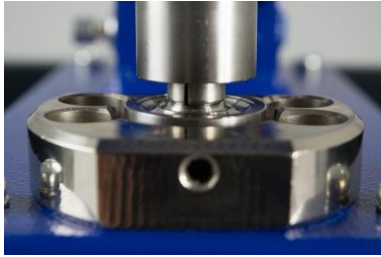

5. Tighten the two Allen screws, slide the upper die upwards and downwards and control again for the correct position.

5.2 Die for plastic eyelets

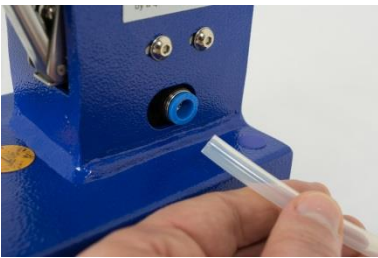

1. Remove the compressed air hose.

For the remainder of the installation procedure there must be no pressure on the device!

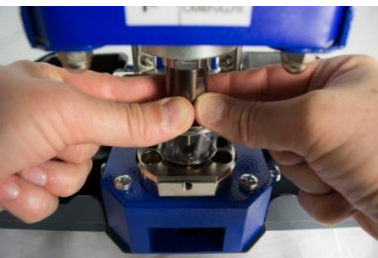

2. Actuate the manual operating lever to drive the finger guard downwards. Then pull the upper die downwards with the other hand.



3. Check the position of the upper die relative to the lower die. The dies must be exactly centred over each other and the upper die must fit into the lower die without snagging.

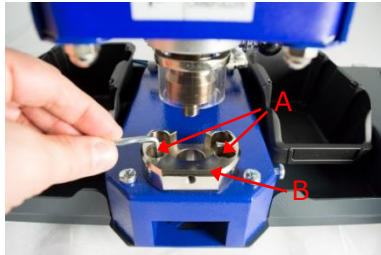

4. If necessary, loosen the two Allen screws A and slide the lower bracket B together with the die to the correct position.



5. Tighten the two front screws on the lower bracket.



6. Slide the upper die several times completely into the lower die and control that the upper die is centred in the lower die without snagging.

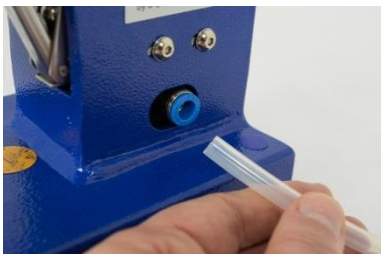

7. Connect the compressed air hose.



8. Slowly drive the finger guard downwards with the manual operating lever and control that the upper die is centred in the lower die without snagging. If this is not the case, adjust the die as described in Section 5.1.

Faulty adjustment causes poor results and can damage the die. Such damage is not under warranty!

5.3 Finger guard



The speed with which the finger guard moves down can be adjusted with the setting screw. This can compensate for differences in the compressed air supply. Rotating in the clockwise direction reduces the speed. This adjustment affects only the use of the footpedal.

6 CE Declaration of Conformity

We, the

DATAPLOT GmbH
Gutenbergstraße 15
24558 Henstedt-Ulzburg
Germany

as the manufacturer of the brand **EMBLEM**, hereby declare that we are solely responsible for ensuring that the machine:

- Brand: EMBLEM
- Model: Airpress Standard 4

conforms to the following EU Directives and EU standards:

Machinery Directive 2006/42/EC
EN ISO 12100:2010
EN ISO 4414:2010
EN ISO 13857:2008
EN349:1993 + A1:2008